

6. RESPONSE TIME

Adjust response time as follows. The unit does not detect the passing object faster than the response time set. If the response time is set longer, the unit does not detect human beings. Adjust to a little longer response time in a site where large passing objects, newspaper or carton box may move.

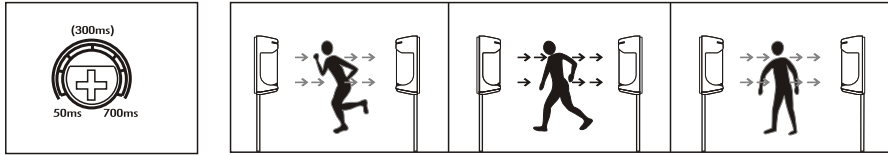

7. TROUBLESHOOTING

Trouble	Possible Origin(s)	Remedy(s)
Transmitter LED does not light.	Incorrectly wired and/or insufficient voltage	Ensure the power supply to the transmitter is 10 to 30 VDC.
Receiver LED never lights up when the beam is interrupted.	a. Insufficient voltage b. Beam reflected away from receiver c. Beams not simultaneously interrupted.	a. Double-check the voltage. b. Clean the cover. c. Check overall installation.
Beams interrupted and LED lights, but no alarm trigger.	Alarm trigger cable may be cut, or the relay contact stuck due to overloading.	Check the continuity of the wiring between the sensor and the alarm.
Alarm LED continuously lit.	a. Lenses out of alignment. b. Beam are blocked. c. Cover is foggy or dirty.	a. Realign the lenses. b. Remove any obstacles. c. Clean the cover.
Alarm trigger becomes erratic in bad weather.	Lenses out of alignment.	Check overall system installation. If still erratic, realign the lenses.
Frequent false triggers from leaves, bird, etc.	a. Too sensitive. b. Bad location.	a. Reduce the response time. b. Change the transmitter and/or location.

8. SPECIFICATIONS

Model	PB-10HD	PB-25HD	PB-30HD	PB-60HD	PB-80HD	PB-120HD
Max. range(outdoor)	33'(10m)	83'(25m)	100'(30m)	200'(60m)	260'(80m)	400'(120m)
Max. range(indoor)	66'(20m)	166'(50m)	200'(60m)	400'(120m)	520'(160m)	800'(240m)
Current	61mA	63mA	65mA	69mA	73mA	77mA
Power	10~30VDC(Non-polarity)					
Detection system	50~700msec(variable)					
Alarm output	Contact capacity:NC./NO. 1A/120VAC					
Tamper output (Tx & Rx)	NC switch, 1A@120VAC					
Alarm LED (Receiver)	Red LED -ON:When transmitter and receiver are not aligned or when beam is broken.					
Signal LED (Receiver)	Yellow LED -ON:When receiver's signal is weak or when beam is broken.					
Power LED (Receiver and Transmitter)	Green LED -ON:Indicates connected to power.					
Laser wavelength	650nm					
Laser output power	≤5mW					
Alignment angle	Horizontal: ±90°, Vertical: ±15°					
Operating temperature	-23°F(-25°C) to +131°F(+55°C)					
Weight	2.5lbs.(1.1kg)					
Case	PC Resin					
Humidity	<70%					

** No laser beam alignment :PB-10HD/PB-25HD

** With laser beam alignment :PB-30HD/PB-60HD/PB-80HD/PB-120HD

9. EXTERNAL DIMENSIONS

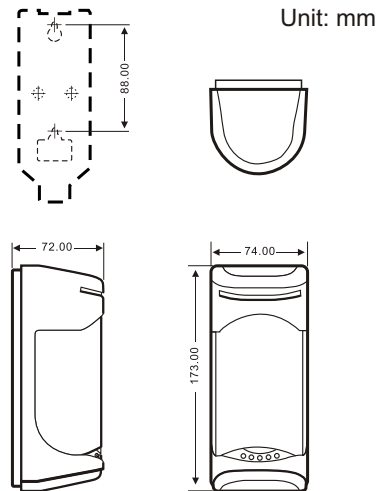

Twin Photoelectric Beam Sensors PB-10HD/25HD/30HD/60HD/80HD/120HD

Features:

Range—

- PB-10HD :Outdoor 33ft.(10m),Indoor 66ft.(20m) (No laser)
- PB-25HD :Outdoor 83ft.(25m),Indoor 166ft.(50m) (No laser)
- PB-30HD :Outdoor 100ft.(30m),Indoor 200ft.(60m) (With laser)
- PB-60HD :Outdoor 200ft.(60m),Indoor 400ft.(120m) (With laser)
- PB-80HD :Outdoor 260ft.(80m),Indoor 520ft.(160m) (With laser)
- PB-120HD :Outdoor 400ft.(120m),Indoor 800ft.(240m) (With laser)

- Twin beam provide reliable perimeter security minimizing false alarms from falling leaves,birds,etc.
- Lensed optics reinforce beam strength and provide excellent immunity to false alarms due to rain,snow,mist,etc.
- Weatherproof,sunlight-filtering case for indoor and outdoor use.
- Anti-frost system so that beam functions even in extreme conditions.

- Automatic input power filtering with special noise rejection circuitry.
- N.C./N.O. Alarm output.
- N.C. Tamper circuit included.
- Non-polarized power inputs.
- Quick,easy installation with built-in laser beam alignment system.

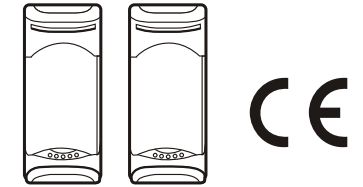

INSTALLATION MANUAL

1. PARTS DESCRIPTION

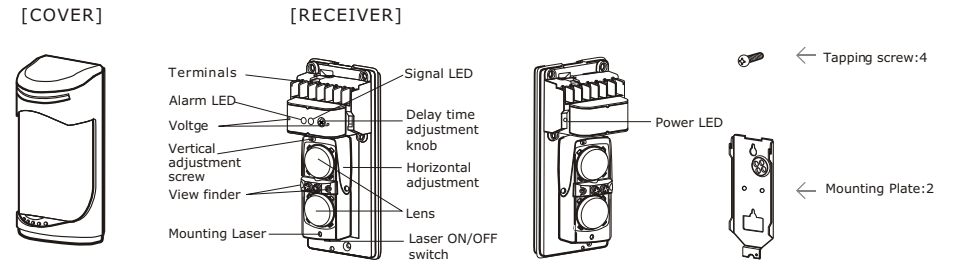

2. CAUTIONS ON INSTALLATION

Do Not

- ◆ Remove all abstractions (trees,clothes,lines,etc.) between Transmitter and Receiver.
- ◆ Avoid strong light from the sun, automobile headlights etc.directly shining on Transmitter/Receiver. When strong light stays in optical axis for a long time,it does not cause malfunction but will affect the product life.
- ◆ Do not install the unit on places where it may be splashed by dirty water or direct sea spray.
- ◆ Do not install the unit on unsteady surfaces.

Expansion of beam

The protection distance(between Transmitter /Receiver)should be placed in the rated range.

Model	Detection distance	Spred of beam
PB-10HD	10m(33 ft.)	0.6m(2.0 ft.)
PB-25HD	25m(83 ft.)	0.9m(3.0 ft.)
PB-30HD	30m(100 ft.)	0.9m(3.0 ft.)
PB-60HD	60m(200 ft.)	1.8m(6.0 ft.)
PB-80HD	80m(260 ft.)	2.4m(8.0 ft.)
PB-120HD	120m(400 ft.)	3.6m(12.0 ft.)

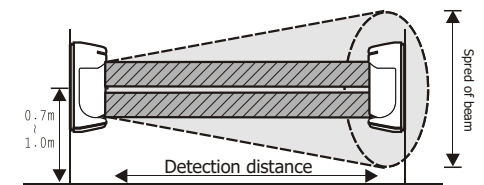

Position of installation

The photoelectric beam lens can be adjusted horizontally $\pm 90^\circ$, and vertically $\pm 15^\circ$. This allows much flexibility in terms of how the transmitter and receiver can be mounted. Install at a distance of 32" to 39" (80 to 100cm) above the ground for most situations.

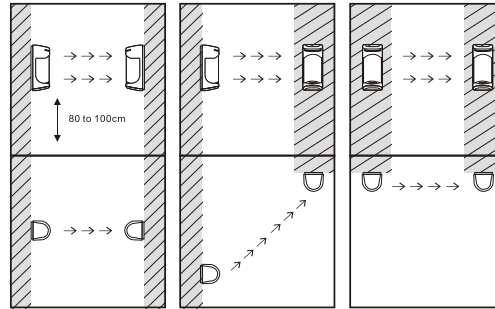
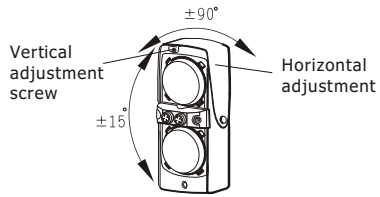

3. WIRING

Wiring

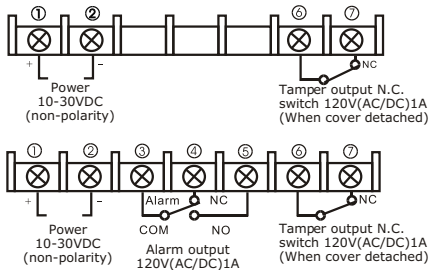

Connection

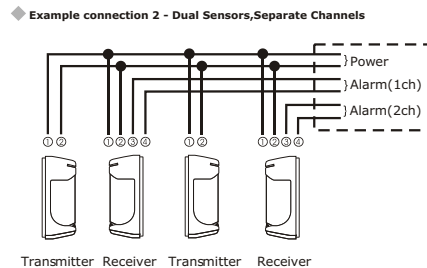
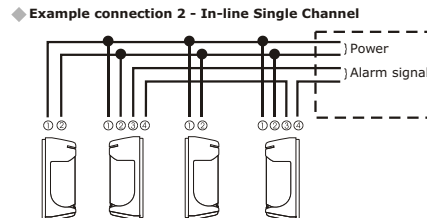
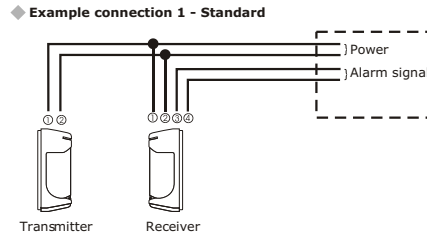

Running the Cable

Run a cable from the alarm control panel to the photobeam sensor. If burying the cable is required, make sure to use electrical conduit. Shielded cable is strongly suggested. See table 1 for maximum cable length.

Table 1: Cable Length

Model No.	PB-10HD		PB-25HD		PB-30HD	
	12V	24V	12V	24V	12V	24V
AWG22	360m	3,200m	320m	2,800m	320m	2,800m
AWG20	600m	5,400m	550m	4,800m	550m	4,800m
AWG18	1,000m	8,640m	800m	7,200m	800m	7,200m
AWG16	1,200m	12,000m	980m	8,800m	980m	8,800m
Model No.	PB-60HD		PB-80HD		PB-120HD	
	12V	24V	12V	24V	12V	24V
AWG22	280m	2,400m	200m	1,600m	110m	900m
AWG20	450m	4,200m	350m	3,000m	170m	1,400m
AWG18	700m	6,200m	500m	4,200m	250m	2,200m
AWG16	850m	7,600m	590m	5,200m	310m	2,600m

Note(1): Max. cable length when two or more sets are connected is the value show in Table 1 divided by the number of sets.
Note(2): The power line be wired to a distance of up to 3,300 ft. (1,000m) with AWG22(0.33mm) telephone wire.

4. INSTALLATION METHOD

Wall Mount

- Loosen the cover locking screw and remove the cover. Loosen the unit setting screw at lower part of unit base. Side the mounting plate downwards and remove it.
- Pull wire through on the installation site.
- Break grommet on mounting plate and pull wire through it. Secure the plate with 4mm screws.
- When exposed wired break knockouts (2 positions) on the rear of unit, pull wire through as the figure and attach it to the mounting plate.

Note: Plug opening between grommet and wire with sealing materials.

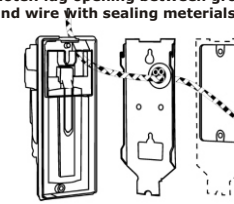
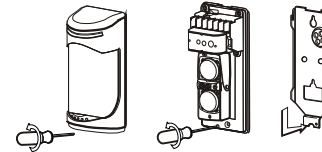

Pull wire through sensor body (back to front) and attach it to the mounting plate.

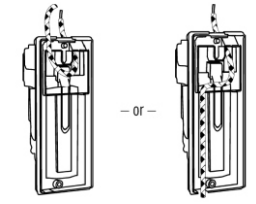

After wiring is completed, adjust alignment, check operation and attach cover.

Pole Mount

- Use dia 38mm to 45mm pole.
- Insert 2 pcs. of oval countersunk head screws (M4x20) in a pole bracket with a few rotation.
- Fix pole mounting plate to pole with pole bracket.
- Detach cover, and remove mounting plate from sensor body.
- Temporarily insert 2 pcs of M4x10 screws in pole mounting plate and fix sensor, mounting plate on them.
- Do the same procedure as (3)-(5) of wall mount.

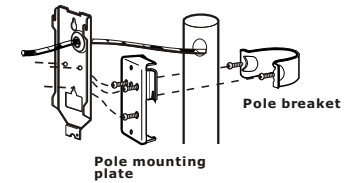

5. ALIGNMENT AND OPERATION

Eyeball adjustment

- Remove the transmitter cover, and look into one of the alignment viewfinders (one of the four holes located between to two lenses) at a 45° angle.
- Adjust the horizontal angle of the lens vertically and horizontally until the receiver is clearly seen in the viewfinder.
- Repeat steps 1 and 2 for the receiver.
- Replace the transmitter and receiver covers.

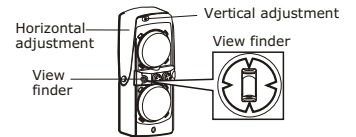

NOTE: If you cannot see the opposite unit in the viewfinder, put a sheet of white paper near the unit to be seen,

Laser adjustment

- Remove the transmitter cover, then turn the laser on with the ON/OFF switch.
- Adjust the transmitter's sensor unit vertically and horizontally until the red dot is centered on the receiver and both the receiver's LEDs turn off.
- Repeat steps 1 and 2 for the receiver.
- Turn the lasers off, and then replace the covers.

WARNING: Do not look directly at the lasers.



Alarm and signal LEDs	Signal strength
Two LEDs OFF	Best
One LED ON	Good
Two LEDs ON	Re-adjust

Fine Tuning the Receiver

- Once the sensor is mounted and aligned, the sensor can be fine tuned using the voltage output jack.
- Set the range of a volt-ohm meter (VOM) to 0~10VDC.
- Measure the voltage.
- Adjust the horizontal angle by hand until the VOM indicates the highest voltage.
- Adjust the vertical angle by turning the vertical adjustment screw until the VOM indicates the highest voltage.

Voltage output	Alignment quality
3.4~5V	Best
1.15~3.4V	Good
1.0~1.15V	Fair
<math><1.0\text{V}</math>	Re-adjust

